

# ZAZA 2 CONNECT

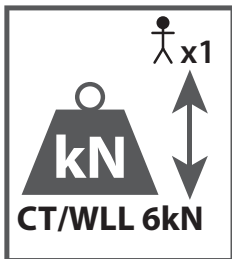

## AVANTAGES/ADVANTAGES

- Solution pour saut pendulaire  
Solution for pendular Jump
- Solution pour les verticalités  
Solution for Verticalities
- Solution pour les jeux roulants  
Solution for rolling Games
- SIMPLE et INTUITIF à partir de 10/12ans/SIMPLE and INTUITIVE from 10/12 years old



**Safety Line / Ligne de vie :**  
Ø 12 mm or 1/2 "  
Galvanized steel wire rope with metal core /  
Câble acier galvanisé avec âme métallique :  
-7x19 / 1x19  
-Non rotating wire rope / Anti-giratoire  
-6x26 Swaged/ Compacté

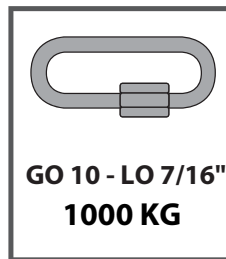

**EN 15567-1**  
**EN 13411-1/7**  
**STANDARDS**

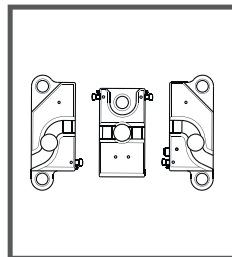
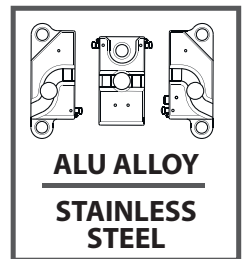

=

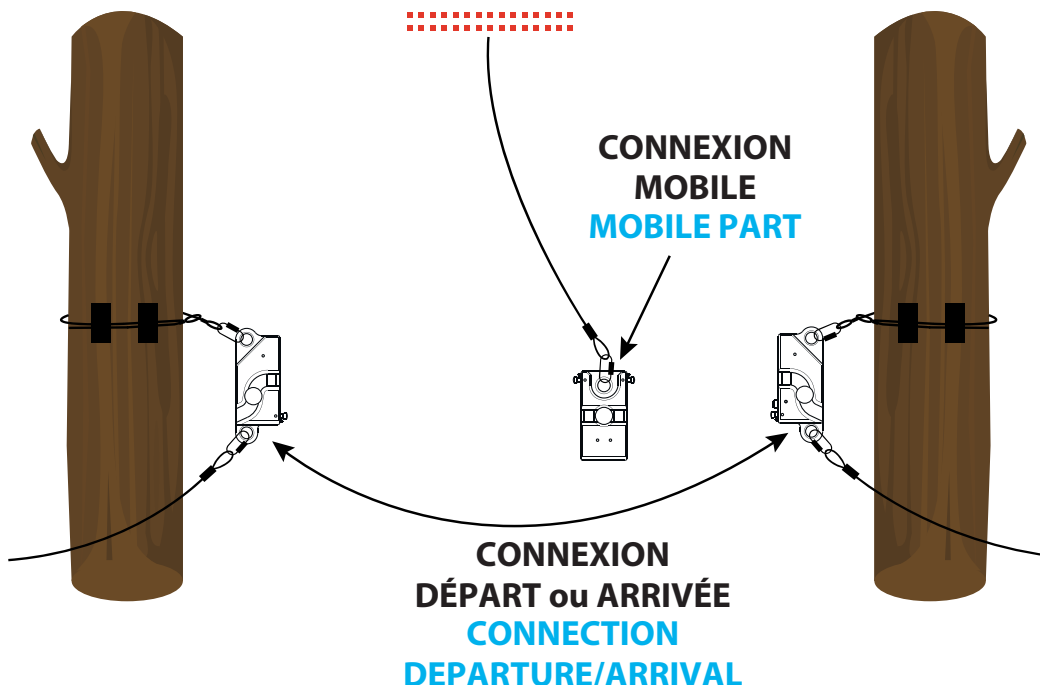
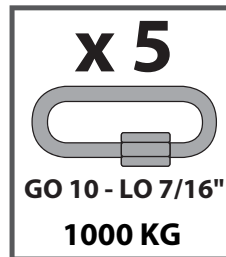

## Opération 1

= CHOIX du sens de CIRCULATION/CHOICE OF RUNNING DIRECTION

- MONTAGE PISTON DE BLOCAGE sur PARTIE ARRIVÉE  
FIT THE LOCKING PISTON ON ARRIVAL PART

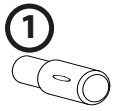

Piston de blocage  
Locking Piston



Ressort  
Spring



Goupille  
Pin



Outil de guidage  
Guiding Tool

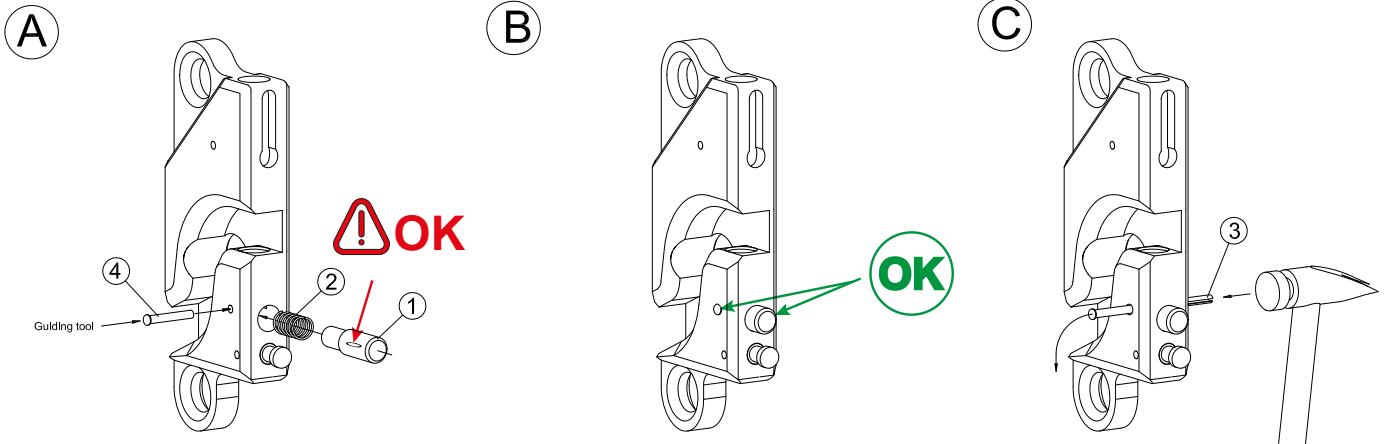

## Opération 2



Lubrification pistons à la mise en service + entretien régulier  
Lubrication pistons before service + regular maintenance

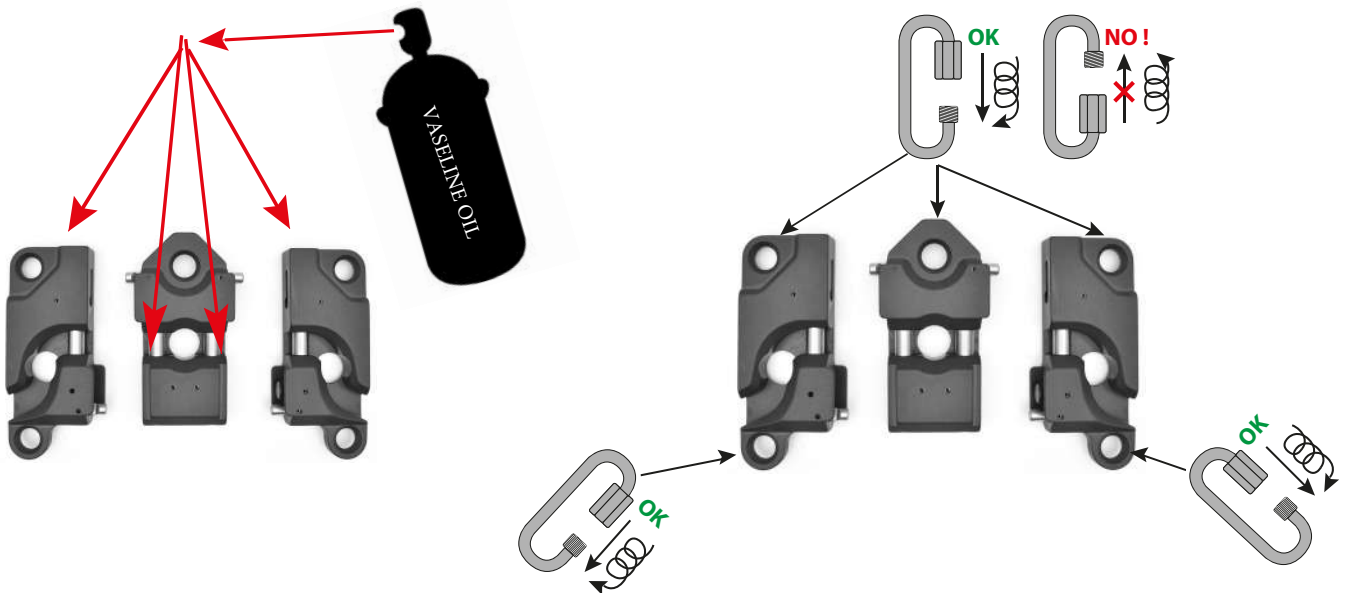

# Opération 3

## EXEMPLES de SYSTEMES de FIXATION DÉPART ou ARRIVÉE FIXING SYSTEME EXAMPLE DEPARTURE/ARRIVAL



Les parties départ/arrivée doivent être très libres  
Departure/arrival part have to be really free

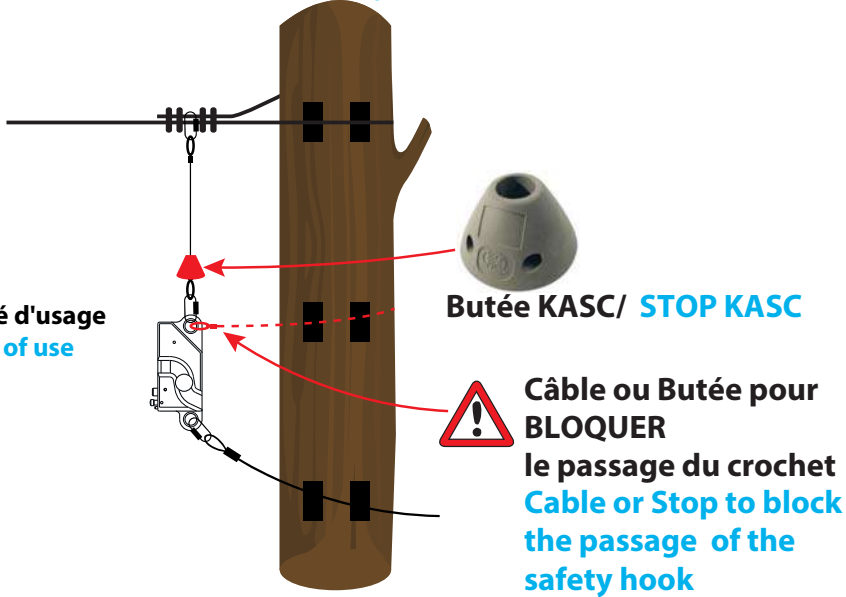
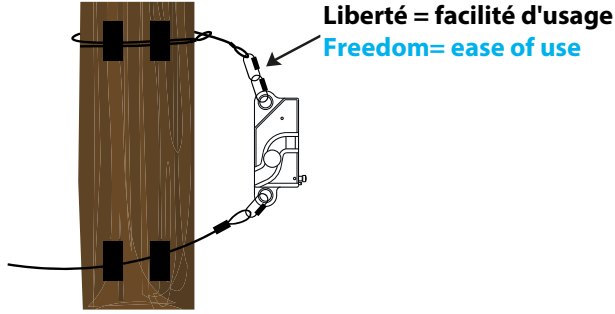

**NORMES DE MONTAGE**  
**STANDARDS OF ASSEMBLY**

EN 15567-1  
EN 13411-1/7  
STANDARDS - ACCT

# Opération 4

EXEMPLE DE FIXATION PARTIE MOBILE  
FIXING EXAMPLE MOBILE PART

JEUX ROULANTS ROLLING GAMES

VERTICALITES/VERTICALITIES

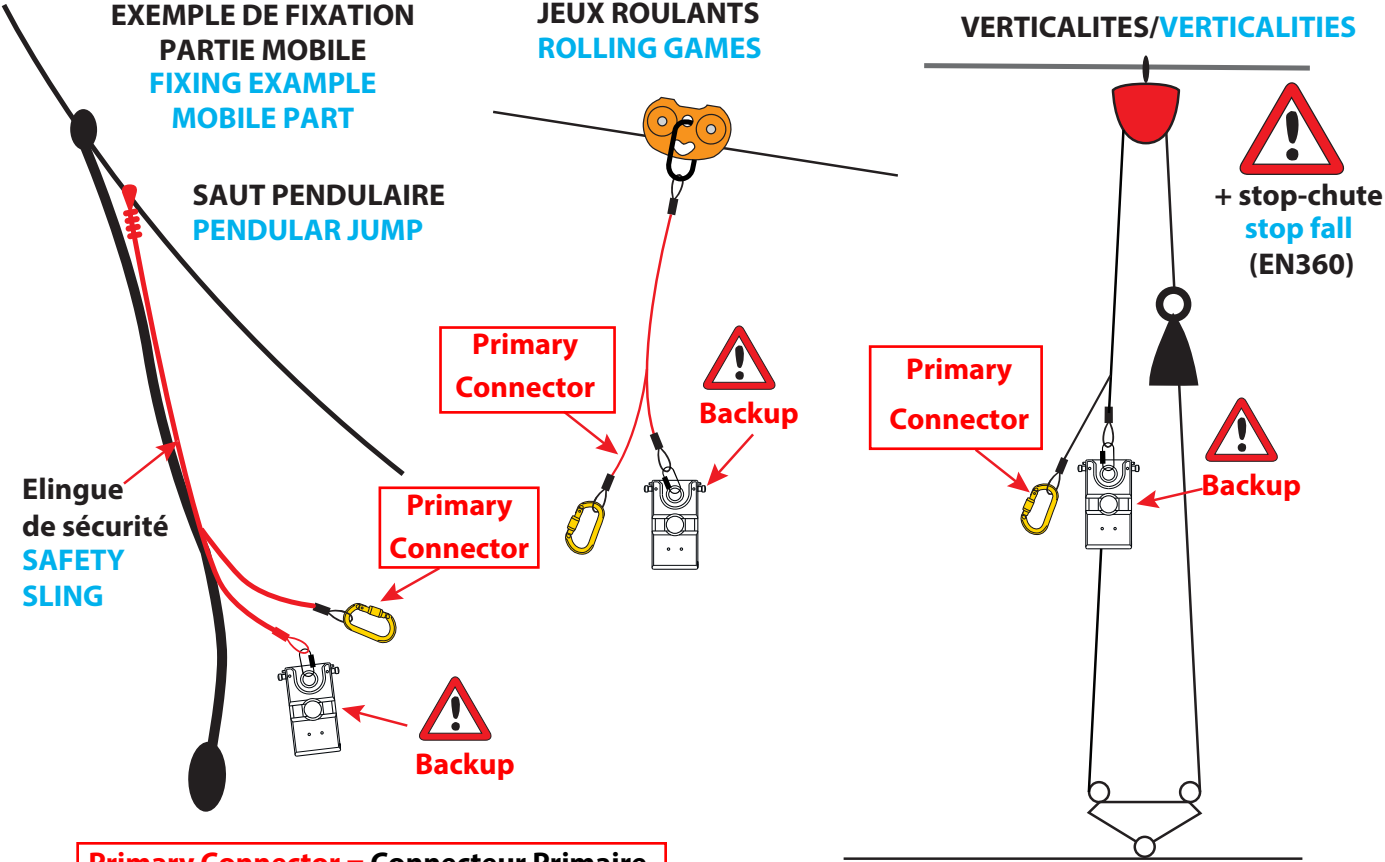

**Primary Connector = Connecteur Primaire**

# Opération 5

● Solution pour saut de tarzan  
Solution for Tarzan jump

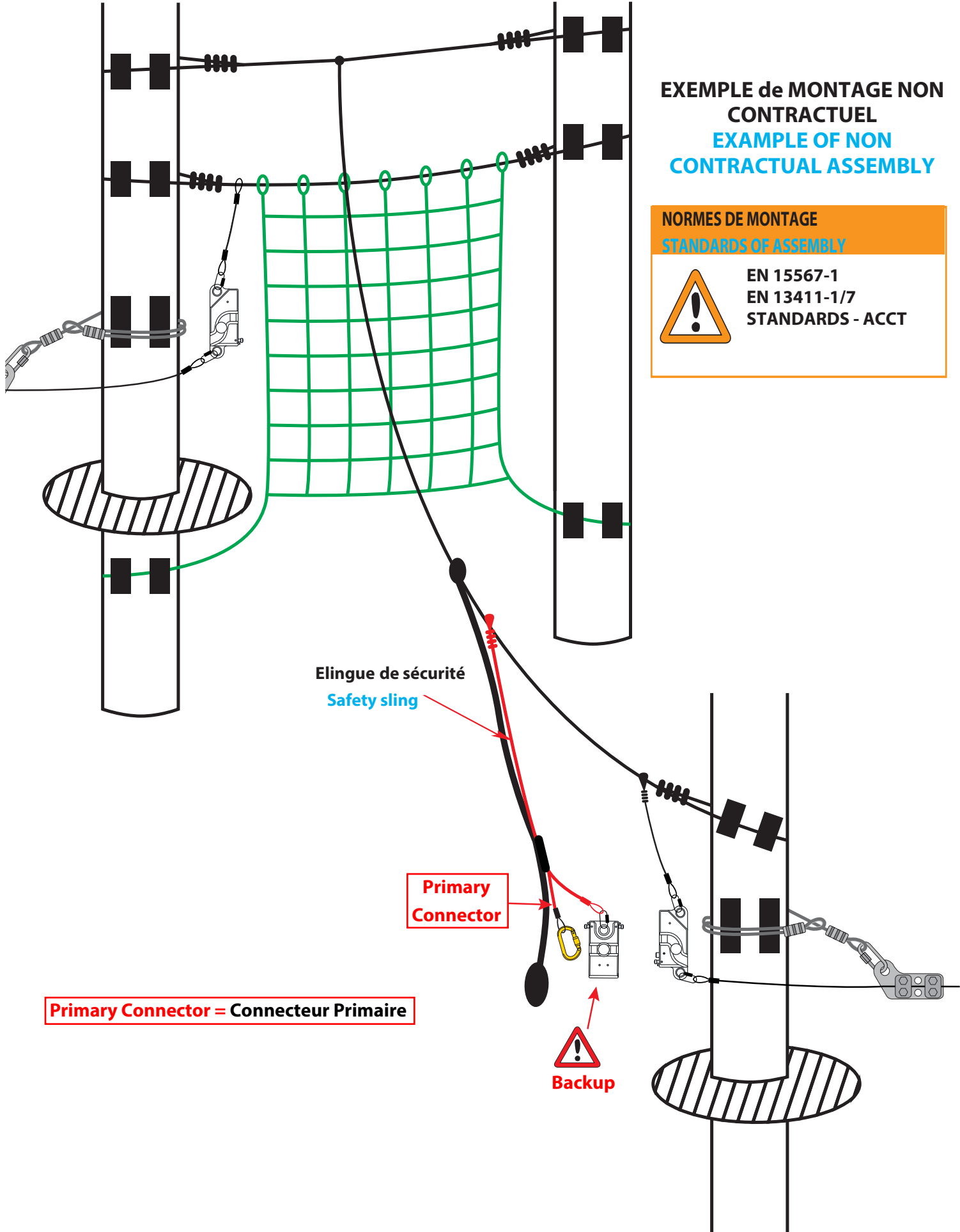

**EXEMPLE de MONTAGE NON CONTRACTUEL**  
**EXAMPLE OF NON CONTRACTUAL ASSEMBLY**

**NORMES DE MONTAGE**  
**STANDARDS OF ASSEMBLY**



EN 15567-1  
EN 13411-1/7  
STANDARDS - ACCT

**Primary Connector = Connecteur Primaire**

**Backup**

# Opération 6

## ● Solution pour VERTICALITÉS Solution for VERTICALITIES

### EXEMPLE de MONTAGE NON CONTRACTUEL EXAMPLE OF NON CONTRACTUAL ASSEMBLY

**NORMES DE MONTAGE**  
**STANDARDS OF ASSEMBLY**



EN 15567-1  
EN 13411-1/7  
STANDARDS - ACCT

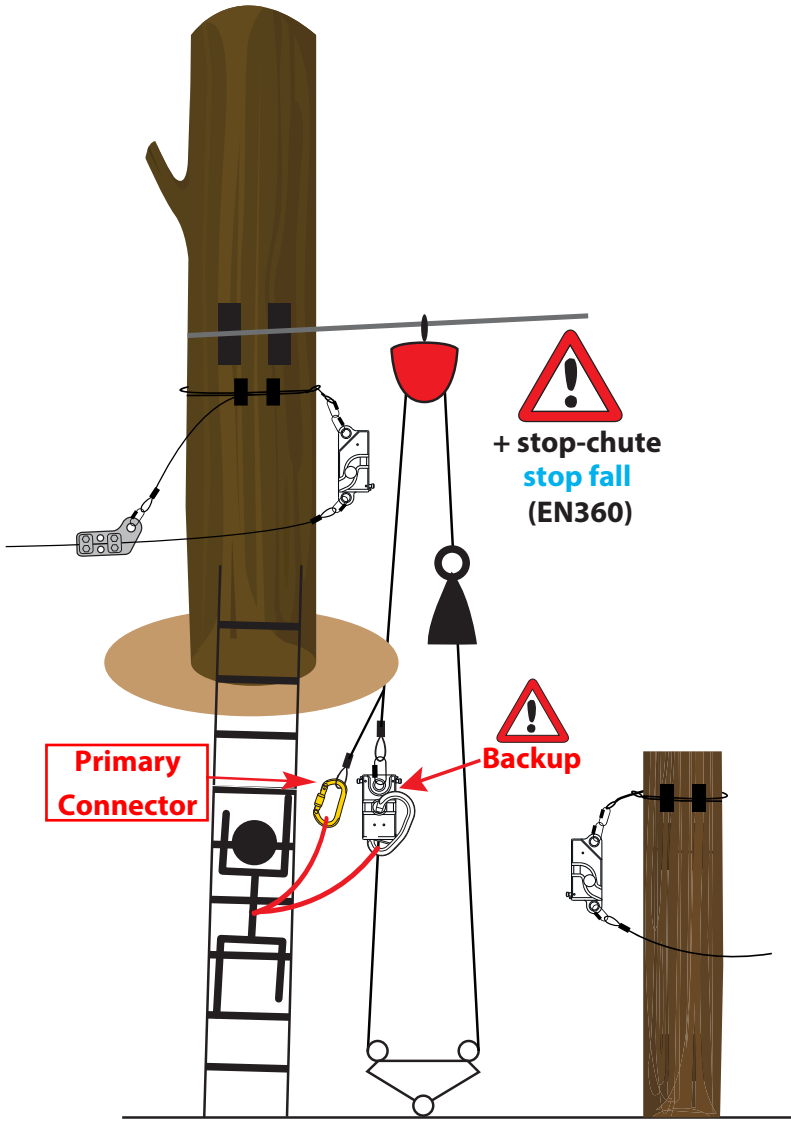

**Primary Connector = Connecteur Primaire**

